

## NT4 - RSK

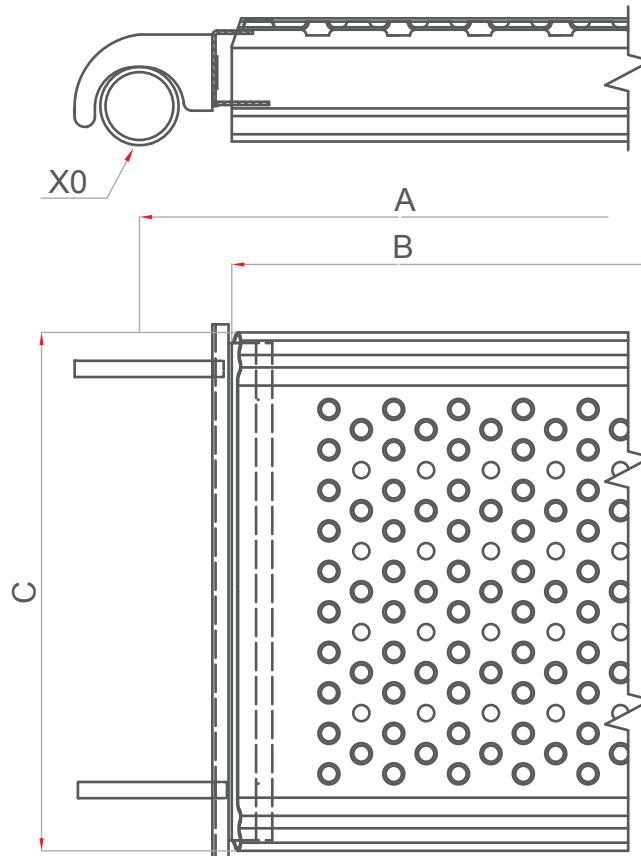

### Technical table

Type / L	A	B	C	X0	Load capacity
NT4RSK/2,09	2090	1976	320	Ø48,3	Gr.5 - 4,5 kN/m <sup>2</sup>
Platform metal plate thickness					1,5
IMBiGS certificate no.					Z/02/024/12

